



SINGER®

Quantum Stylist™

Beautiful Results Are Easier Than Ever.

With over 800 built-in stitches, including block & script alphabets, you'll enjoy the speed, simplicity and durability of the SINGER® 9980 QUANTUM STYLIST™ sewing machine. The built-in sewing advisor ensures sewing success every step of the way. Advanced features like Needle Up / Down for quilting and appliquéing, Pattern Elongation, Stitch Memory with Editing and Automatic Thread Cutter ensure that this is a sewing machine you will love for years to come.



Advanced Features Add a Professional Touch

Drop & Sew Bobbin System

With this special top drop-in bobbin system, there's no longer any need to raise the bobbin thread before sewing. Just drop and sew!

Stitch Memory with Editing

Program up to 60 characters into the sewing machine's memory for easy retrieval, accessible even after the sewing machine has been turned off. Edit the stitches according to length, width, mirroring and elongation!

Thread Breakage Sensor

The sewing machine senses when the upper thread has broken. Sewing will automatically stop without any lost or blank stitches!

25 Needle Positions

Needle position can be changed for individual projects like inserting zippers or cording and topstitching.

Automatic Tension

This system ensures stable stitch quality, whatever type of fabric is being sewn. The tension can be adjusted using the tension adjustment buttons, if desired.

Built-In Sewing Assistance with Audible and Visual Messaging

Simply touch the Help button and instantly learn more about bobbin winding, bobbin setting, threading the upper thread and changing the presser foot.

Automatic Electronic Thread Trimmer

Press the thread cutter button and the machine automatically trims threads when you are done sewing.





SINGER®

Quantum Stylist™



Automatic Needle Threader

Threading the machine is so easy that you can have the entire machine threaded in just six seconds. Threading instructions are even printed on the sewing machine!



Presser Foot Sensor

Ensures the presser foot is in the proper position for an easy start. The machine will not begin to sew if the presser foot is raised, reducing the chance of thread bunching

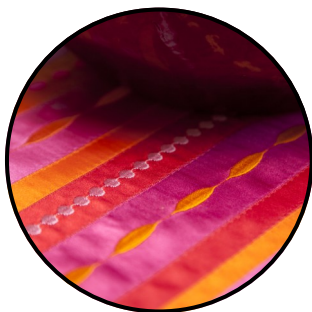

Stitch Elongation

Select the elongation button and a variety of stitches can be made two to five times longer.

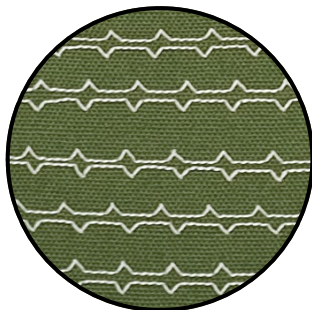

Mirror Imaging

With just a touch of a button select stitches can be mirror imaged, adding even more stitch variety.

Automatic Settings Eliminate Guesswork

Automatic Stitch Length & Width

Optimal settings for stitch length and width are automatically set, but can be overridden for more personalized sewing.

Free Arm

The removable free arm provides easy access to cuffs, collars, pant hems and other difficult-to-reach areas.

Electronic Auto Pilot

Unplug the foot control, press the Start button and the machine sews. You are still in complete control over the speed - just slide the Speed Control lever to the desired maximum speed.

Needle Up / Down Button

Pressing this button when the machine is stopped will change the needle position from down to up or from up to down.

Slow Sewing Speed Button Option

Allows you to sew at slower speeds for intricate work.

Take Your Creativity to the Next Level

Drop Feed with Box Feed Motion

Lower the feed dogs for free-motion embroidery, monograms and for sewing buttons. The feed dogs move in a box motion ensuring perfect feeding throughout the entire feed process.

Adjustable Presser Foot Pressure

Adjustable presser foot pressure allows you to adjust the amount of pressure exerted on your fabric while sewing. The pressure is optimally pre-set, but feel free to override those settings for high pile fabrics or delicate fabrics like chiffon.

7mm Stitch Width

Most stitches can be set for a maximum width of 7mm creating attractive satin and decorative stitches.



SINGER®

Quantum Stylist™



**FREE Accessories Including
13 Presser Feet**
Expands your creative possibilities.



Buttonhole Foot with Underplate
The Exclusive Buttonhole Foot with Underplate sandwiches fabric between lower plate and foot to ensure perfect buttonholes on multiple layers of fabric.

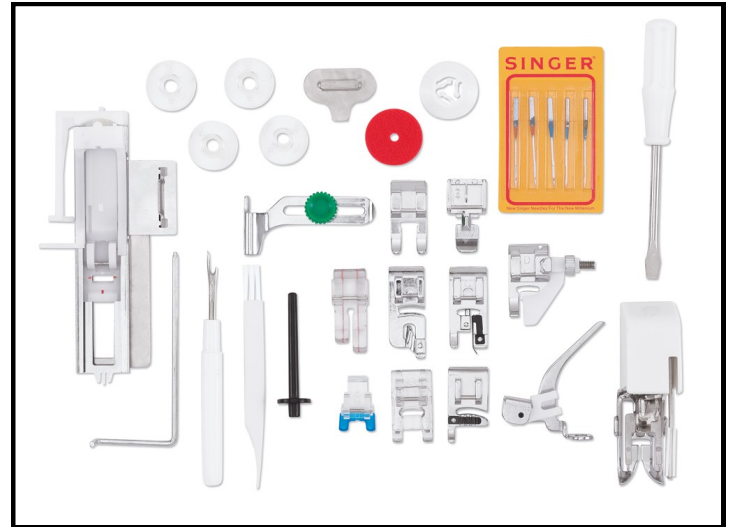

What's In The Box

Included Presser Feet

All-Purpose Foot, Zipper Foot, Buttonhole Foot with Exclusive Underplate, Blind Hem Foot, Satin Stitch Foot, Overcasting Foot, Darning / Embroidery Foot, Narrow Rolled Hem Foot, Button Sewing Foot, Quarter Inch Foot, Open Toe Foot, Even Feed / Walking Foot, Cording Foot

Included Accessories

Needles, Bobbins, Seam Ripper, Lint Brush, Auxiliary Spool Pin, Spool Pin Felt, Screwdrivers, Thread Spool Caps, Edge/Quilting Bar, Soft-Sided Dust Cover, Instruction Manual, Foot Control, Power Cord

Put Your Mind at Ease

Heavy Duty Metal Frame for skip-free sewing.

25-Year Limited Warranty

Bobbin Class 15

Answers At Your Fingertips

Toll-Free Helpline 1-800-4-SINGER (1-800-474-6437)
Monday through Friday, 8:00 a.m. to 4:00 p.m. C.T.

Online Support available any time at singerco.com
Social Media Support allows you to connect with other sewers for tips and tricks!

YouTube.com/SingerSewingCompany offers a variety of helpful videos tutorials including the following topics: Threading, Presser Feet Training, Maintenance and Troubleshooting.

Consumer's Choice - More people own SINGER machines than all other brands combined!

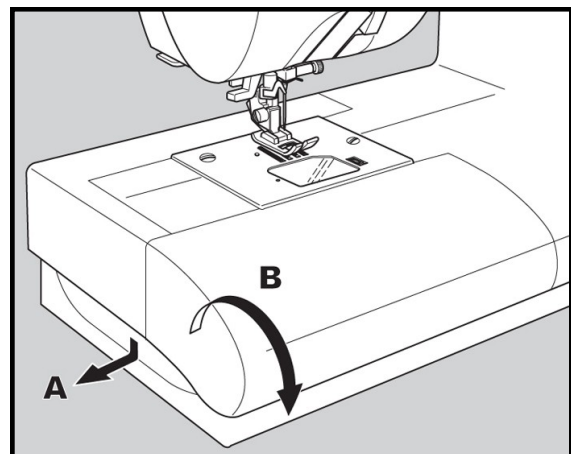



SINGER®

Quantum Stylist™

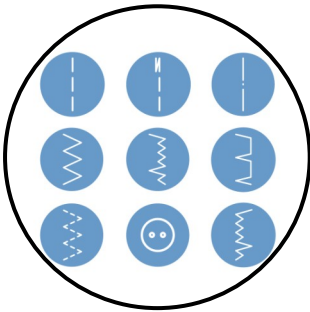

10 Essential Stitches
The core stitches of construction and mending.

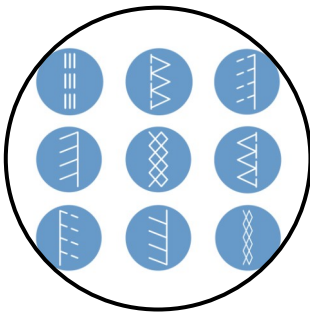

21 Stretch Stitches
Specially designed to move with your fabric.

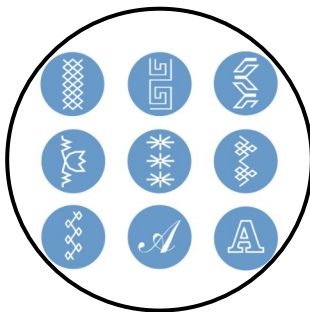

776 Decorative Stitches including Alphanumeric
Create special details on any project.

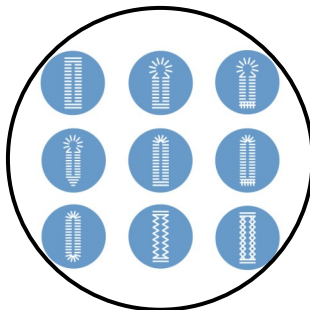

13 Fully Automatic Perfectly Sized Built-In Buttonhole Styles
Buttonhole sewing is a fully automatic one-step simple process providing reliable results every time.



820 Built-In Stitches with Stitch Reference Chart

This chart located on the upper lid of the machine allows you to quickly see all of the 800+ built-in stitches and choose the perfect stitch for your project.

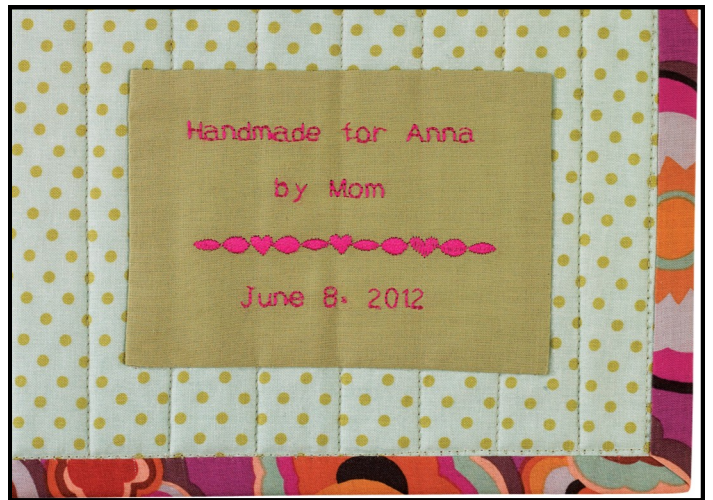

6 Styles of Alphabets & Numerals with Memory

Personalize projects by adding a monogram, name, phrase or date in five standard styles and one Cyrillic style.